



Vision 32[®] / 40[®] Open Cassette Fitting & Operating Instructions

Vision 32[®] / 40[®] Open Cassette Fitting & Operating Instructions

Carefully unwrap the Vision blind and its associated brackets.

There are two bracket options for open cassette blinds, face fix and top fix.

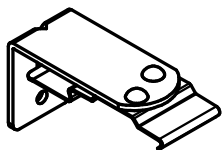

Face fix bracket

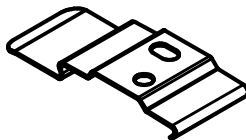

Top fix bracket

Fitting the brackets.

For a blind up to 1 metre wide attach two brackets fitted approximately 75mm (3") from each end of the blind (fig. 1). Any intermediate brackets should be spaced evenly between these and as a general rule:

- Up to 1m = 2 brackets
- 1m to 2m = 3 brackets.
- 2m to 3m = 4 brackets.
- Over 3m = 5 brackets.

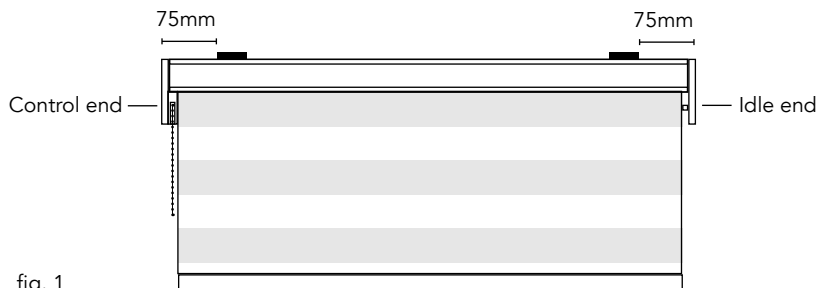

The bracket release lip on the bracket must face the back of the blind.

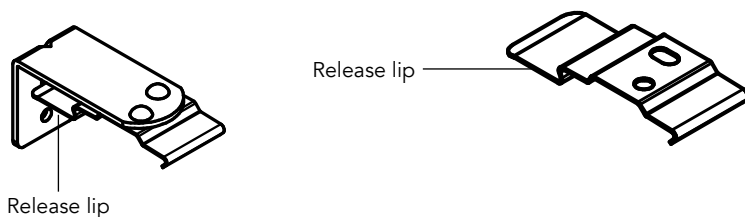

Mark the hole positions before drilling and plugging if necessary. Use two screws in each bracket ensuring that the brackets are level. Remember to allow room for the blind to clear any obstacles when deployed, e.g. door or window handles.

Fitting the cassette

Once all the brackets are in place offer the blind to the brackets. With the cassette tilted away from you locate the front lip into the bracket and push upwards to click the cassette into the back lip of the bracket.



Child Safety

Your blind will be supplied with either Easybreak® connectors attached to the operating chain or a cord tidy that will need to be fitted to the wall.

Easybreak® System

Two Easybreak® connectors are connected to the operating chain 200mm apart (fig. 2). This ensures that at least one of them will be in the vertical position ensuring they perform as required.

If excessive weight is applied within the loop a Easybreak® connector will break apart.

If an Easybreak® connector comes apart then it will need to be re-connected. To re-connect, check the Easybreak® connector for damage. If undamaged, re-connect the chain by inserting the last ball on the end of the chain into the larger hole of the connector and push into place.

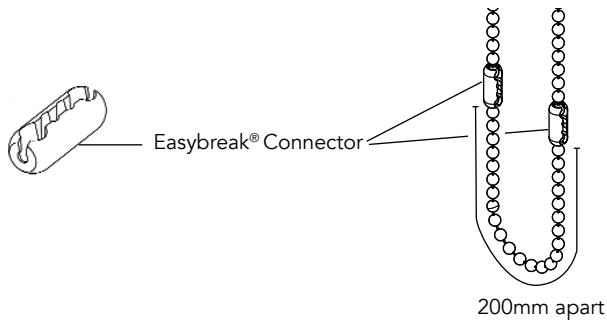

fig. 2

200mm apart

Tensioned System using cord tidy.

If the blind is fitted with a continuous loop chain then a cord tidy will be attached to the chain. This must be fitted to the wall as follows.

Fitting a cord tidy.

The cord tidy is a two piece device and will arrive with a disposable red tab fitted to it (fig. 3).

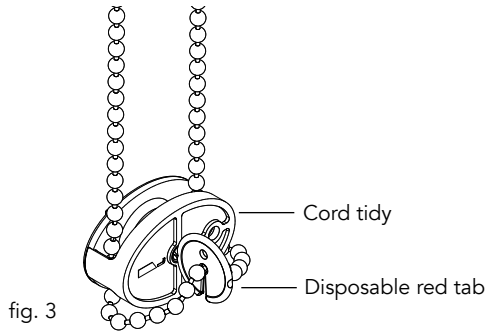

Remove the disposable red tab by disengaging it from the chain (fig. 4) and then pull out the disposable red tab (fig. 5).

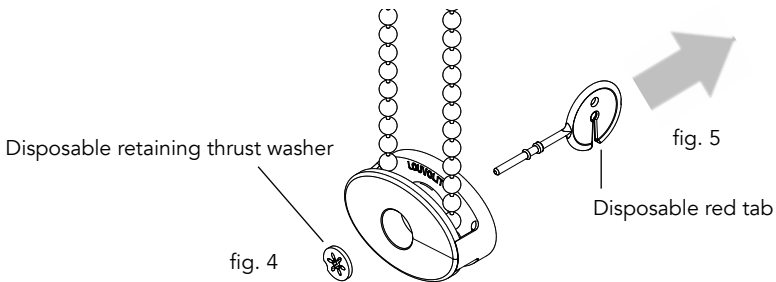

Position the cord tidy to the wall at the furthest distance below the roller tube adding appropriate tension to the chain and mark its location (fig. 6).

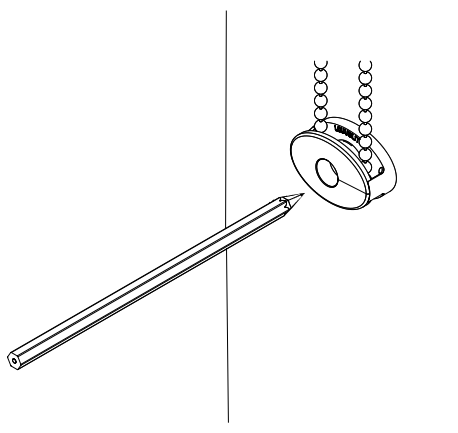

fig. 6

Split the cord tidy (fig. 7) and mark the remaining offset hole position (fig. 8) before drilling and plugging both location holes if necessary (fig. 9). Screw into the offset hole to fix the back piece of the cord tidy to the wall (fig. 10).

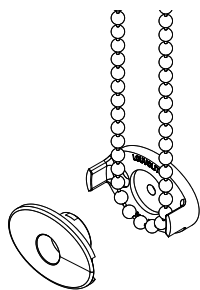

fig. 7

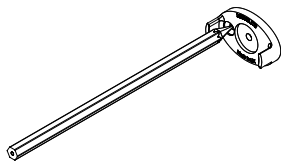

fig. 8

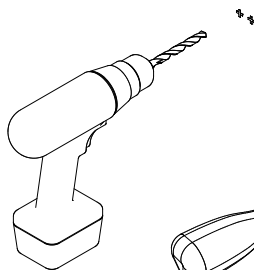

fig. 9

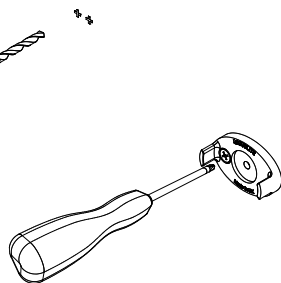

fig. 10

Re-assemble the cord tidy with the chain (fig. 11) and fix it in previously marked position (fig. 6 with a screw through the centre hole (fig. 12).

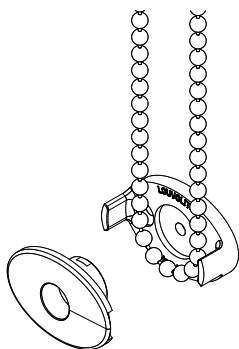

fig. 11

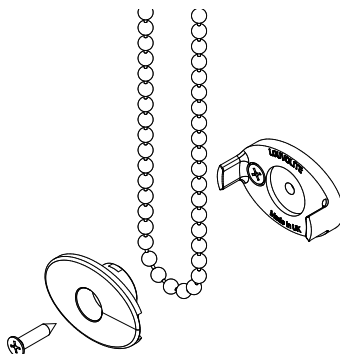
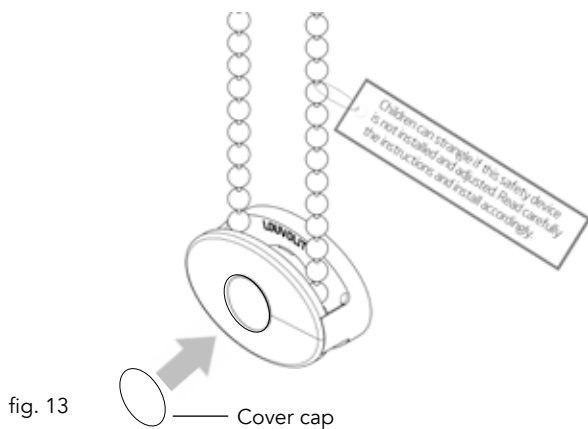

fig. 12

Push fit a cover cap over the screw hole opening (fig. 13).



Operating the blind.

Roller System 32® / 40® Open cassette blinds are reverse rolled. To lower pull the the front chain downwards with a smooth and steady pressure and to raise, use the rear chain.

For a conventional rolled blind, to lower the blind, pull the rearmost length of chain downward. To roll the blind up do the same on the front length of chain.

NOTE TO INSTALLER:

Please ensure a general child safety warning tag is fitted on the product.

Child Safety - EN 13120 Guidelines for Vision Blinds

Tensioned System with Cord Tidy

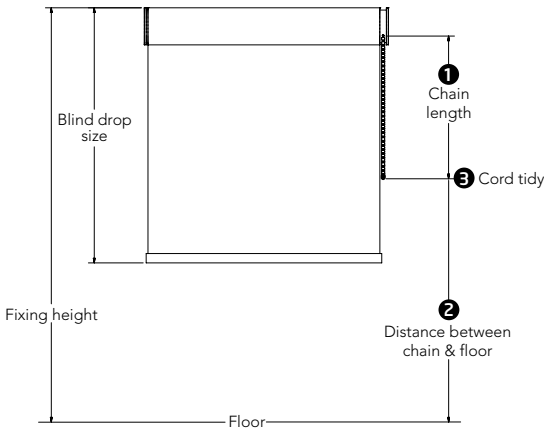

- 1 If fixing height is unknown
 - Blind drop \leq 2.5 metres, the chain length must be \leq 1 metre.
 - Blind drop $>$ 2.5 metres, the chain length must be drop of blind minus 1.5 metres.
- 2 If fixing height known

All blind drop sizes, distance between floor and bottom of chain must be greater than 1.5 metres.
- 3 Cord tidy

Affix cord tidy to wall at the maximum distance possible from the blind control mechanism ensuring all operating cords are taut (chain no more than 50mm apart at entry/exit of cord tidy).

Breakaway Connector System

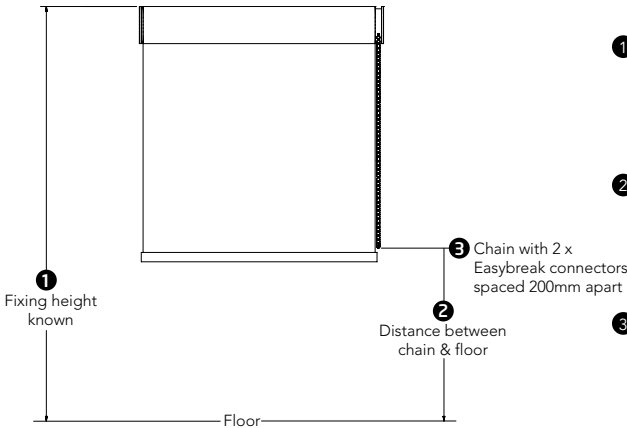

- 1 If fixing height is unknown

Cannot be manufactured - the fixing height must be known to be able to use the Vision® breakaway system.
- 2 If fixing height known

The distance between floor and bottom of chain must be greater than 0.6 metres.
- 3 Chain must be fitted with 2 x Easybreak connectors 200mm apart

Will break apart when excessive force is exerted on the chain.

NOTE TO INSTALLER: Please ensure general child safety warning tag is fitted on the product.

WARNING

Young children can be strangled by loops in pull cords, chains, tapes and inner cords that operate the product.

To avoid strangulation and entanglement, keep cords out of the reach of young children. Cords may become wrapped around a child's neck. Move beds, cots and furniture away from window covering cords.

Do not tie cords together. Make sure cords do not twist and create a loop.



SXXXXXX 02357



Scan this with your smartphone to view Louvolite training videos

